

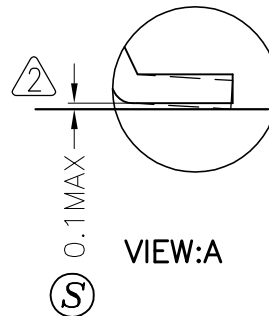

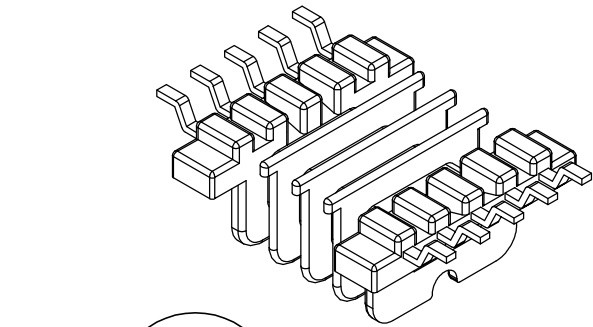

VIEW:A

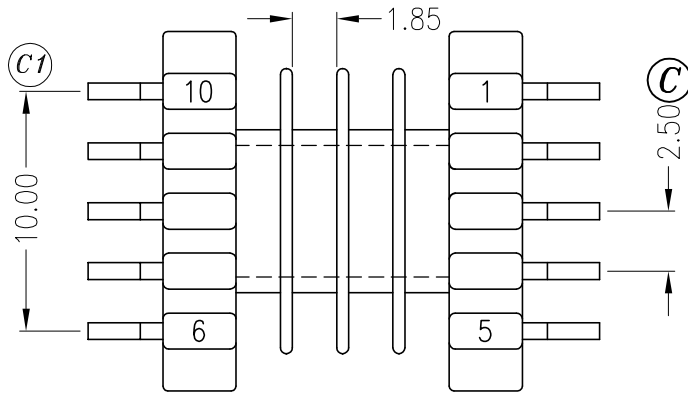
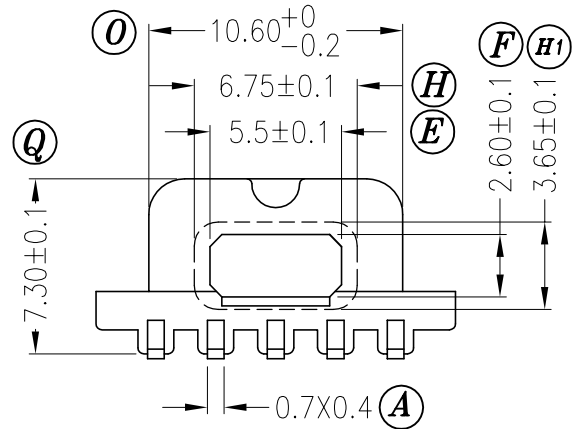

VIEW:A

REV.	REVISIONS	REC.	DATE	REV.	REVISIONS	REC.	DATE
1	UPDATE FORMAT		'04.05.20				
2	 ADD A DIMENSION:(S),AND CORRECT DIM.(T1)&(T2).		'05.04.28				

DRAWN & DRAFTED BY YE JIN HONG	TOLERANCES 0<L≤4 ±0.1 4<L≤16 ±0.2 16<L≤63 ±0.3	pin pitch ±0.2	ANGLE: ±1°	TITLE: SMD BOBBIN EFD-15	
			UNIT: MM	BOBBIN MATERIAL: LCP E4008	UL REC. UL 94V-0
CHECKED & APPROVED BY JOHN RONG	ORIGIN: DG		PIN MATERIAL: PHOSPHOR BRONZE	PIN TENSION LOAD: 1.0KG MIN	
 PIN SHINE INDUSTRIAL CO.,LTD. TEL:886-2-22990545 FAX:886-2-22990546		DATE: ARP.20 '2005	DRAWING NO. S-1509-2	REV. 2	