



Series4 Data Sheet

Visit us on the WEB www.series4.co.uk



Westwood Court, Calmore Industrial Estate, Totton, Hampshire, SO40 3WX England

Tel: +44 (0)23 80 866377 Fax: +44 (0)23 80 866323 Email: paul.m@series4.co.uk

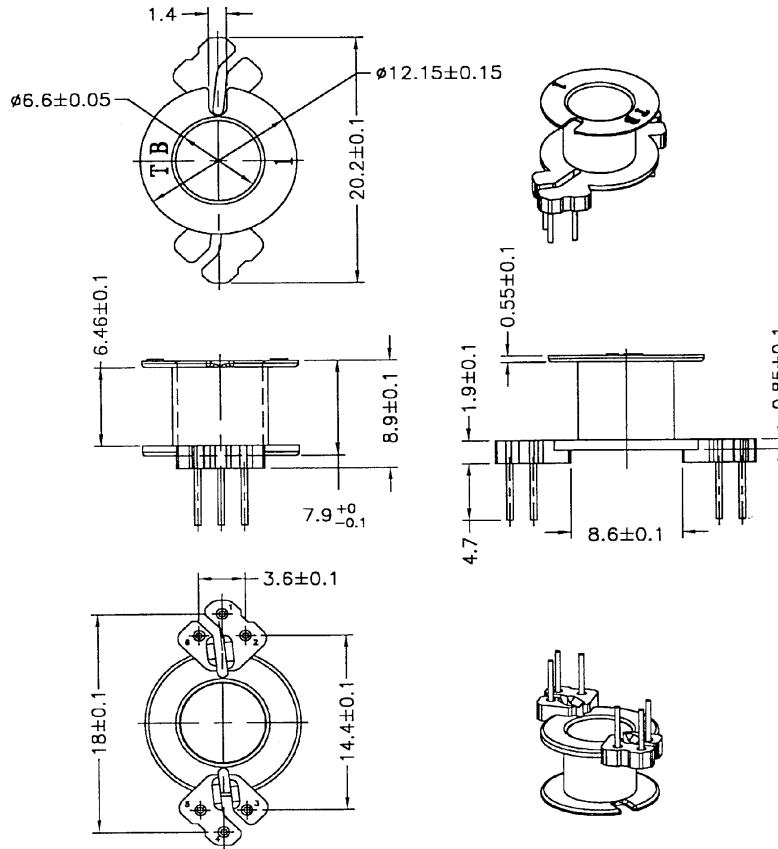

BOBBIN NAME:RM6

Series4 Part No: BCRM6-1-6

OLD REF: S012

SPECIFICATION: 1 SECTION 6 PIN

MODEL	PIN PLATING	PIN TYPE
S012A	CP WIRE	Ø 0.5
S012B	Sn/Pb	Ø 0.5
S012C	CP WIRE	SQ 0.4
S012D	Sn/Pb	SQ 0.4

ALL THE ABOVE PHENOLIC PM9630 MATERIAL

TOLERANCE:

.X +/- 0.1

.XX +/- 0.05

UL: 94V-0

UNIT: MM